

LUTRON® INTEGRATION via SOMFY CONNECT™ UAI PLUS

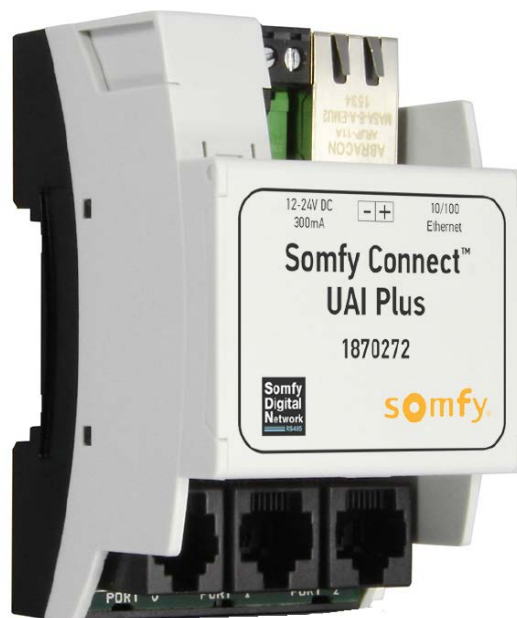

TABLE OF CONTENTS

I.	OVERVIEW -----	3
	DESCRIPTION	
	SYSTEM REQUIREMENTS	
	CONNECTIONS & LEDS	
	LUTRON COMPATIBILITY	
II.	INSTALLATION -----	4
	MOUNTING & POWER	
	WIRING TO SYSTEM FOR OPERATION	
III.	LUTRON SYSTEM SETTINGS -----	5
	NETWORK SETTINGS	
	TELNET SETTINGS	
	INTEGRATION SETTINGS	
IV.	UAI PLUS SYSTEM SETTINGS -----	8
	CONNECTING TO UAI PLUS INTERFACE	
	NETWORK & INTEGRATION SETTINGS	
	SDN INTEGRATION REPORT	
V.	INTEGRATION CONFIGURATION -----	11
	LUTRON DEVICES	
	ADDING LUTRON DEVICES	
	COMMAND MAPPING LUTRON DEVICES	
	TESTING & VALIDATION	
	BUTTON PROGRAMMING EXAMPLES	

I. OVERVIEW

The Somfy Connect™ UAI Plus is designed to commission and control residential and commercial Somfy Digital Network™ (SDN) motors through IP and RS-232 serial communication.

Integration for the Somfy Connect UAI Plus enables third-party control from Lutron® systems including HomeWorks® QS, RadioRA 2, RA2 Select, GRAFIK Eye® QS, Quantum® and myRoom Plus.

SYSTEM REQUIREMENTS

PC running Windows 10 or higher

Chrome 59.0.3071 or higher

Latest Somfy Connect UAI Plus Firmware

NOTE: A PC running Windows 10 or higher with Chrome 59.0.3071 or higher is required for motor commissioning and Somfy Connect UAI Plus firmware updates. A mobile device can be used to control motors once commissioning is complete.

CONNECTIONS & LEDS

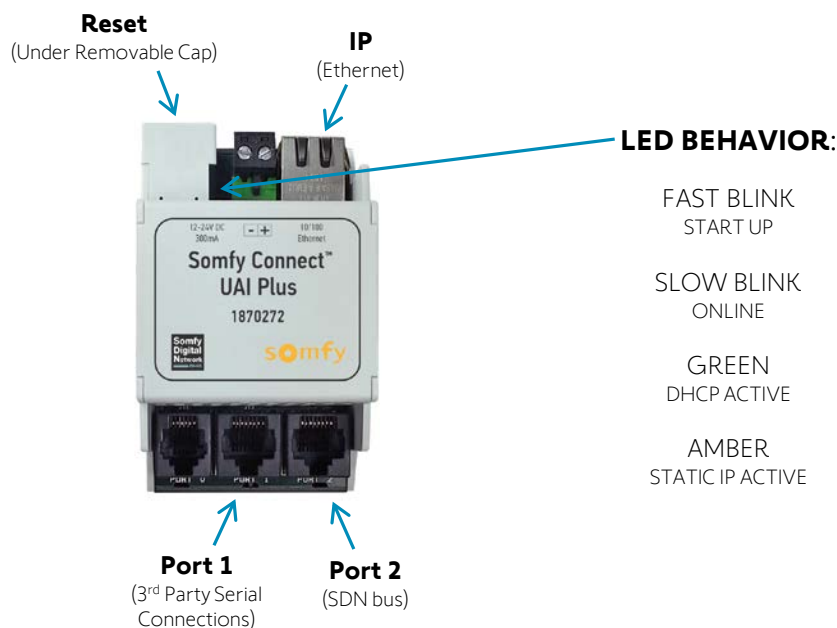

LUTRON COMPATABILITY CHART

Platform	Compatibility	Lutron System Requirements
GRAFIK Eye QS	Yes	QSE-CI-NWK-E
Caseta	No	-
RA2 Select	Yes	RR-SEL-REP2-BL
RadioRA 2	Yes	RR-MAIN-REP
HomeWorks QS	Yes	HQP6-1or 2
Quantum	Yes	QSE-CI-NWK-E
myRoom Prime	No	-
myRoom Plus	Yes	GCU-HOSP
Vive	No	-

II. INSTALLATION

MOUNTING & POWER

The Somfy Connect UAI Plus is mounted on a DIN rail either near an automation system, network switch, or anywhere close to the beginning of an SDN network.

Power is received through the SDN bus via a Bus Power Supply

WIRING TO SYSTEM FOR OPERATION

IP Integration

- Connect Ethernet Port to the building IP network to which the 3rd Party System is also connected
- Connect Port 2 to any SDN Device Port

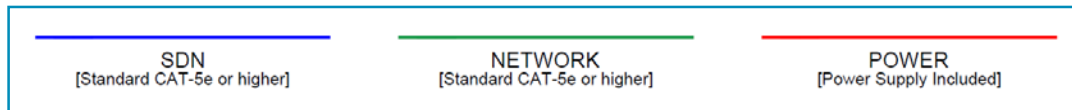
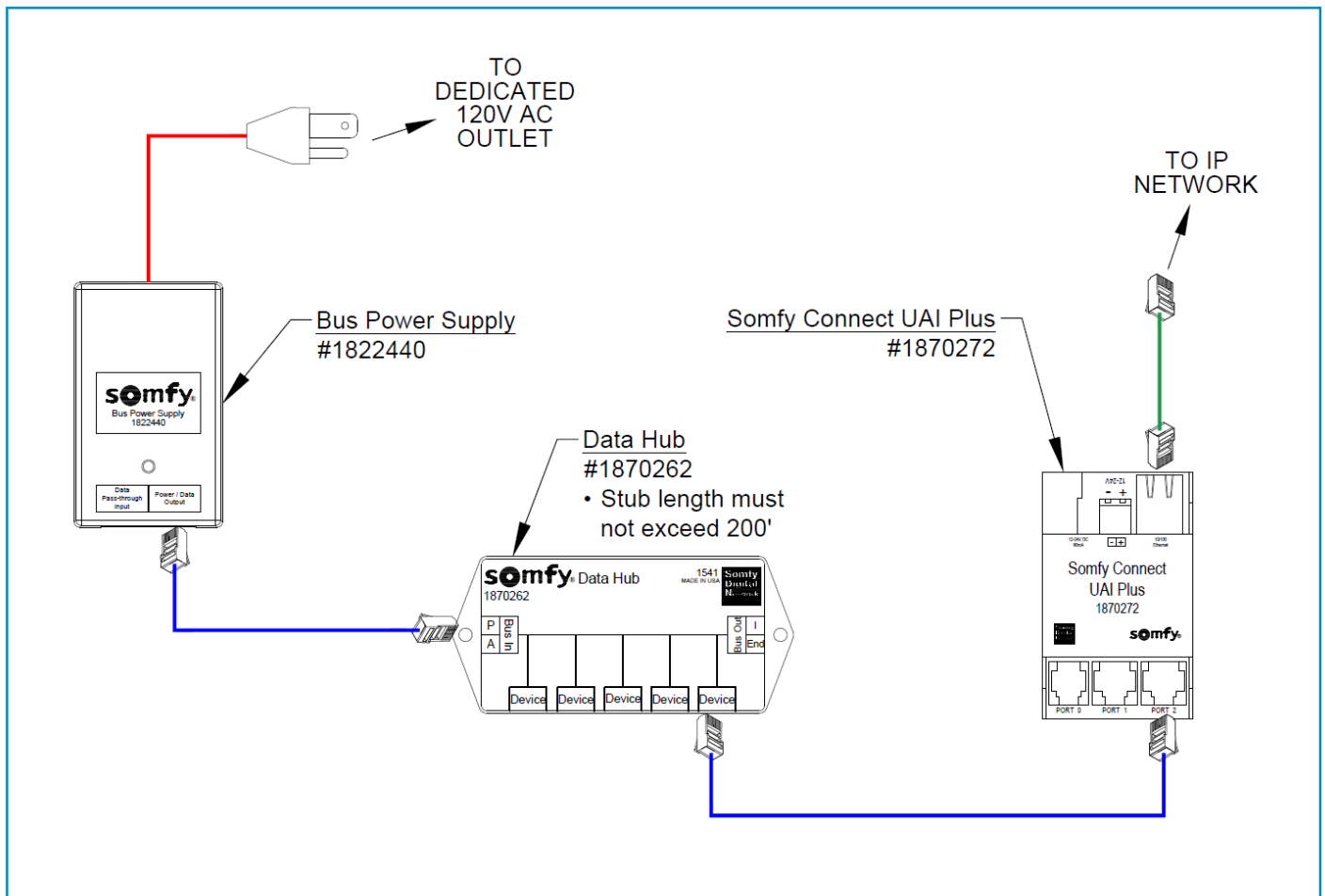

III. LUTRON SYSTEM SETTINGS

LUTRON NETWORK SETTINGS

The Lutron Integrator must disable DHCP and provide an assigned IP Address, entered in the UAI Plus Ethernet Settings

NOTE: A Static IP Address is required to maintain Telnet connection

HOMEWORKS QS:

The screenshot shows the 'diagnostics' tab in the Lutron Homeworks QS interface. A table lists network settings for 'Enclosure Device 001'. The 'DHCP' checkbox is unchecked, and the 'IP Address' is set to 192.168.1.10. Below the table, the 'Advanced Settings' section includes fields for System Number (1), System Address (239.0.38.1), Gateway Address (192.168.1.1), Subnet Mask (255.255.255.0), Primary DNS (192.168.1.1), and Secondary DNS (8.8.8.8). There are also checkboxes for 'Restrict communications with Processor to Local LAN only' and 'Disable Home Control+ Remote Access'.

Name	Serial #	MAC Address	DHCP	IP Address	Subnet Mask	Gateway	Status
Enclosure Device 001	1	0101477C	<input type="checkbox"/>	192.168.1.10	255.255.255.0	192.168.1.1	Not Resp

Activating processors will send the configuration from the project to the processor on the network. This includes network information and all other configuration settings.

Advanced Settings

System Number: 1 System Address: 239.0.38.1

Gateway Address: 192.168.1.1 Subnet Mask: 255.255.255.0

Primary DNS: 192.168.1.1 Secondary DNS: 8.8.8.8

Restrict communications with Processor to Local LAN only (Requires transfer to take effect)

Disable Home Control+ Remote Access

RADIO RA2:

The screenshot shows the 'Find Main Repeater' screen in the Lutron Radio RA2 interface. A table lists network settings for the 'Main Repeater'. The 'DHCP' checkbox is unchecked, and the 'IP Address' is set to 192.168.1.20. Below the table, there are fields for Subnet Mask (255.255.0.0), Preferred DNS Server (192.168.1.1), Gateway Address (192.168.1.1), and Alternate DNS Server (8.8.8.8). There are also buttons for 'Save and Close', 'Save only', and 'Cancel'.

Room	Serial Number	DHCP	IP Address	Status
Equipment Room	006A98C0	<input type="checkbox"/> Disabled	192.168.1.20	Offline

Subnet Mask: 255.255.0.0 Preferred DNS Server: 192.168.1.1

Gateway Address: 192.168.1.1 Alternate DNS Server: 8.8.8.8

RA2 SELECT:

The first screenshot shows the 'My Home' app interface with a gear icon in the top left corner highlighted. The second screenshot shows the 'Settings' menu with the 'Advanced' option highlighted. The third screenshot shows the 'Network Settings' screen with the 'DHCP' toggle switch highlighted.

GRAFIK EYE QS, QUANTUM & MYROOM PLUS:

**Network Settings will need to be configured upon initial setup and provided by the Lutron Integrator*

LUTRON TELNET SETTINGS

The Lutron Integrator must create a dedicated Telnet Username and Passphrase, entered in the UAI Plus Telnet Settings

NOTE: Telnet channels cannot be shared. If running the Lutron Home Control + app and the Somfy Connect UAI Plus application, it is necessary to establish two separate Telnet channels for these two operations to occur.

HOMEWORKS QS:

Username	Access Level	Button Editing	Timeclock Editing	Passphrase	Enabled?
Default Home Control+ User	User	Add / Edit	Add / Edit	Preconfigured	Yes
admin	User	Add / Edit	Add / Edit	Change Passphrase	Yes
UAIPlus	User	Add / Edit	Add / Edit	Set Passphrase	Yes

RADIO RA2:

Username	Password	Button Editing	Timeclock Editing
Default Home Control+ User	Preconfigured	Add / Edit	Add / Edit
UAIPLUS	1234	Add / Edit	Add / Edit

RA2 SELECT:

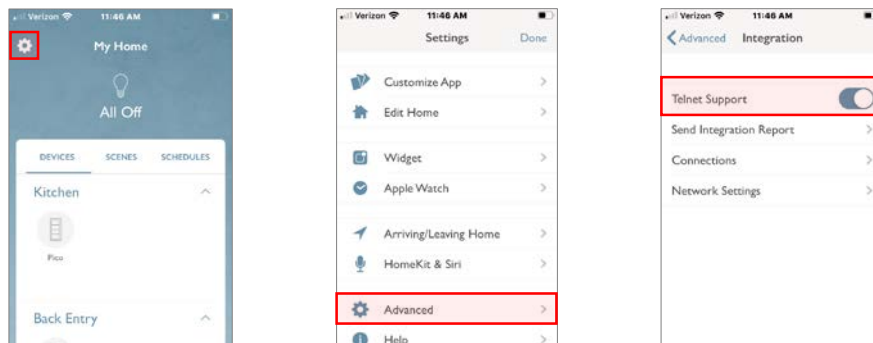

NOTE: RA2 Select is limited to only one Telnet connection

GRAFIK EYE QS, QUANTUM & MYROOM PLUS:

**Telnet Settings will need to be configured upon initial setup and provided by the Lutron Integrator*

LUTRON INTEGRATION SETTINGS

For the Somfy Connect UAI Plus to see Lutron devices they must be enabled for integration.
All required devices should be confirmed enabled by the Lutron Integrator.

HOMEWORKS QS:

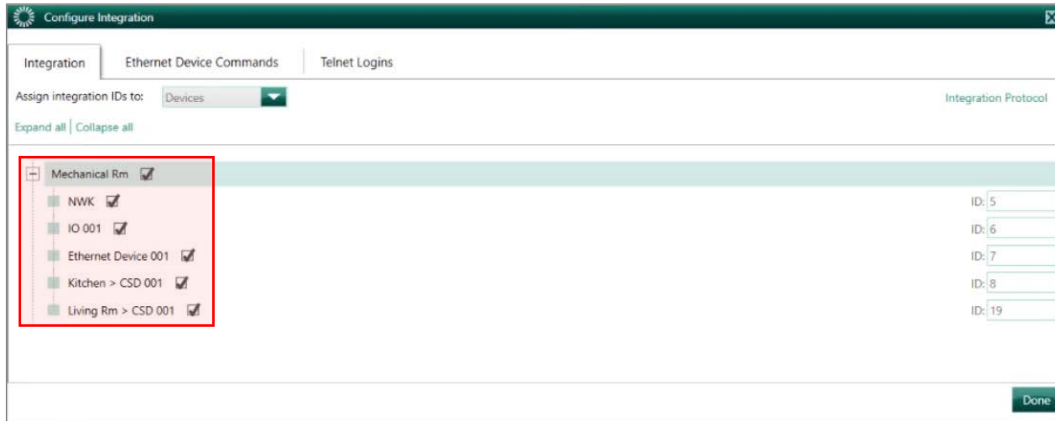

RADIO RA2:

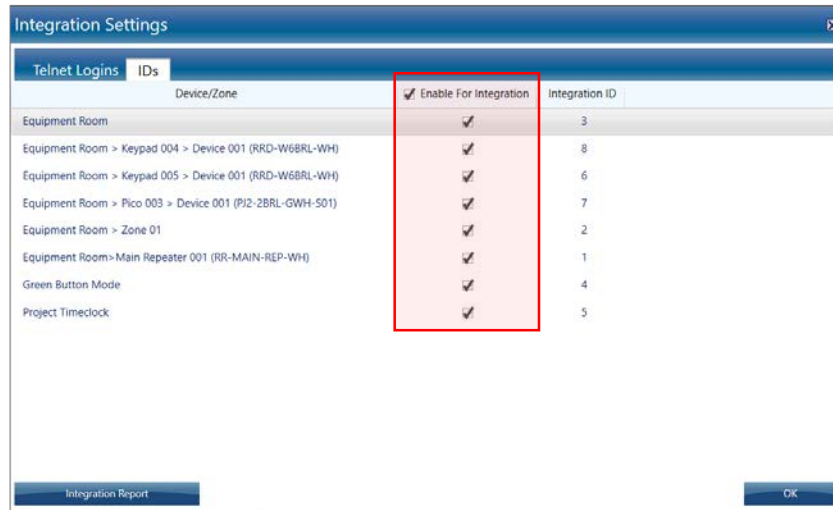

RA2 SELECT:

**RA2 Select integration can only be enabled for the entire system and not individual devices*

GRAFIK EYE QS, QUANTUM, MYROOM PLUS:

**Integration Settings will need to be configured upon initial setup and provided by the Lutron Integrator*

IV. UAI PLUS SYSTEM SETTINGS

CONNECTING TO UAI PLUS INTERFACE

1. Disable the WiFi on the computer, unless connecting to the UAI Plus over a WiFi network
2. Connect Windows PC to the Ethernet Port on the UAI Plus
3. Open the File Explorer then double-click the Network folder

Note: If prompted that network discovery is turned off, click "OK". Right-click on the top bar then choose "Turn on network discovery and file sharing". In the following window, double-click "No, make the network that I am connected to a private network".

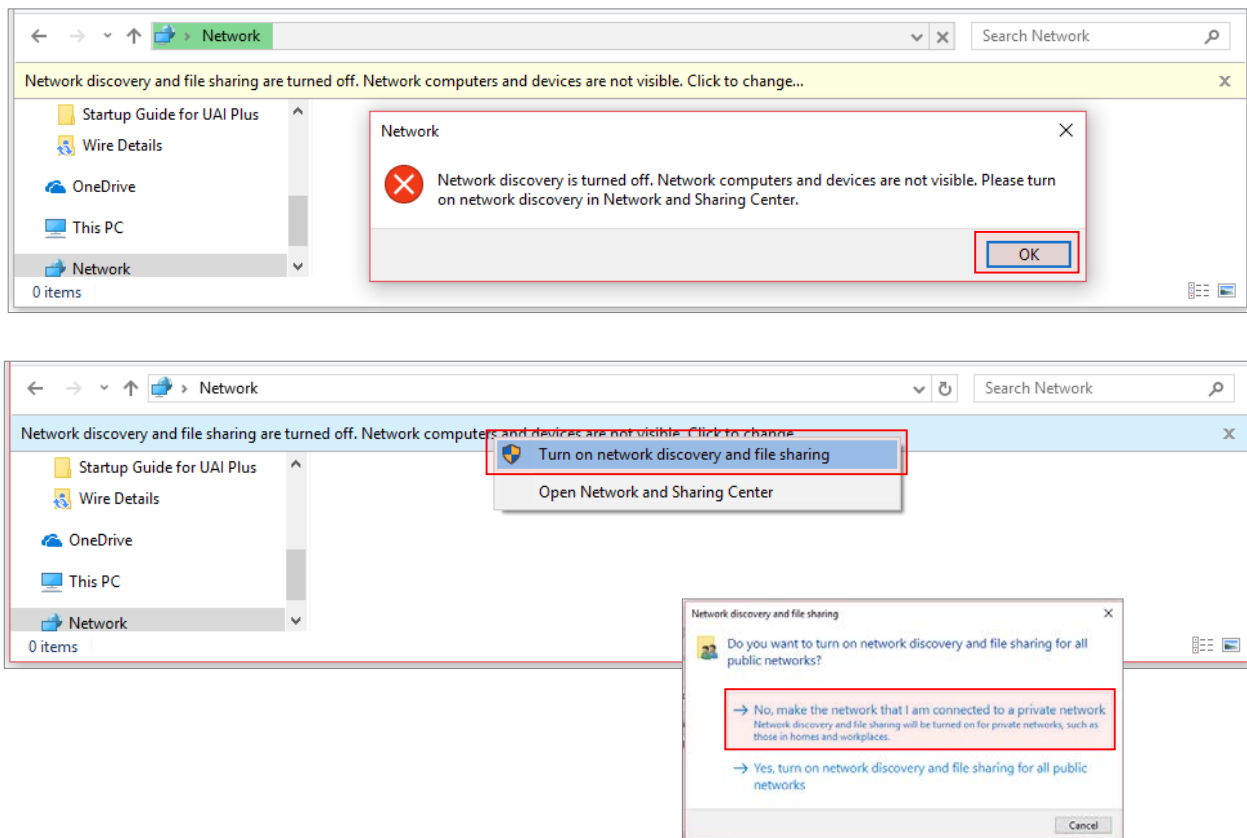

4. The UAI Plus icon will appear in the list of devices, which means it is now connected. Double-click the UAI Plus icon in the device list to open a web browser connecting to the UAI Plus homepage



NETWORK & INTEGRATION SETTINGS

NOTE: Prior to integration, confirm the UAI Plus and SDN System are fully configured and functional.

From the Somfy Connect UAI Plus homepage, hover over the three bars on the top right then click “Settings”:

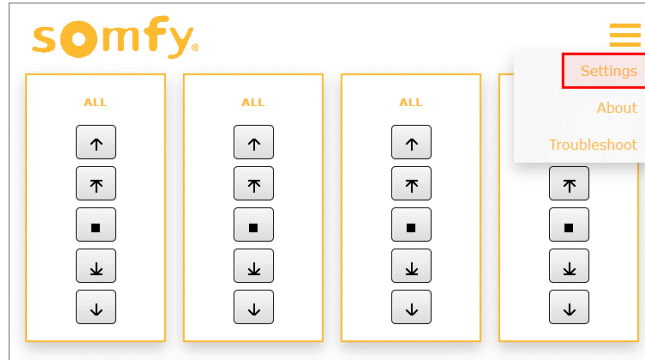

Open the UAI Plus tab to enter the UAI Plus Settings & Properties page:

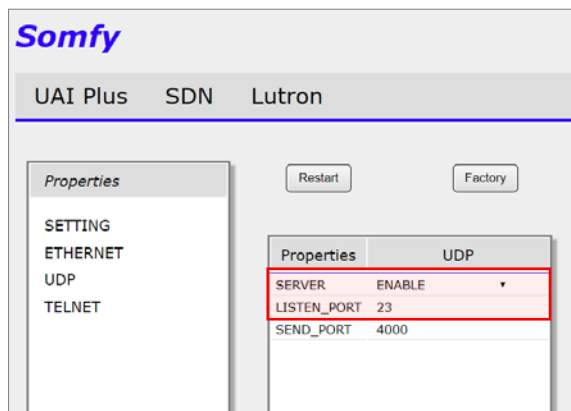

UDP:

1. Confirm SERVER is set to ENABLE
2. Set LISTEN_PORT to 23
3. Click Restart to enable new settings

Open the Lutron tab to enter the Lutron Settings & Properties page:

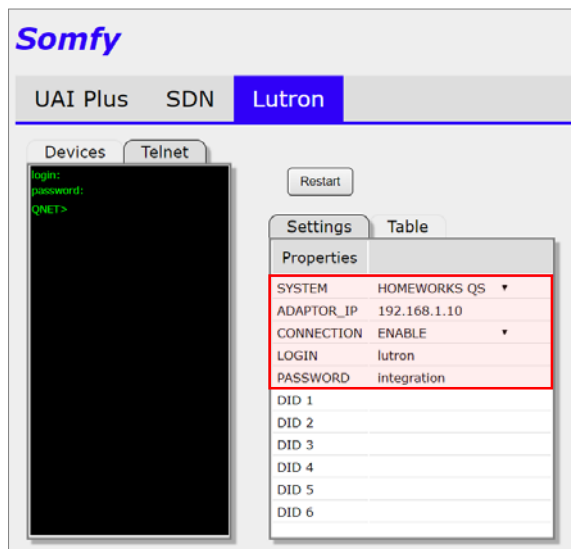

TELNET SETTINGS:

1. Select the Lutron System from SYSTEM dropdown
2. Enter Lutron IP Address in the ADAPTOR_IP field
3. Select ENABLE from the CONNECTION dropdown
4. Enter Telnet Login Username in the LOGIN field
5. Enter Telnet Login Passphrase in the PASSWORD field – within a few moments the login will take place

NOTE: A Telnet Username and Password is not required for RA2 Select

SDN INTEGRATION REPORT

To generate the SDN Integration Report, hover over the SDN tab then click "Report". The Integration Report is downloaded as a .csv file and viewed in Excel.

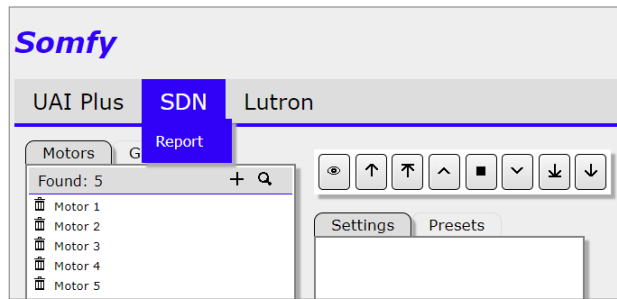

The Integration Report lists the available group addresses required for Lutron integration. The Group Name is selected when command mapping Lutron devices.

UAI+IP Address	192.168.1.3				
MAC Address	00.1B.C5.00.07.1A				
UAI+ Firmware Version					
Telnet Users	Telnet 1	Telnet 2	Telnet 3	Telnet 4	
Telnet Passwords	Password 1	Password 2	Password 3	Password 4	
Motors	LABEL	Group 1	Group 2	Group 3	Group 4
072D94	Motor 1	1st Floor South	All 1st Floor	All South	
072D91	Motor 2	1st Floor East	All 1st Floor	All East	
073AD1	Motor 3	1st Floor West	All 1st Floor	All West	
0754ED	Motor 4	2nd Floor South	All 2nd Floor	All South	
0754EA	Motor 5	2nd Floor East	All 2nd Floor	All East	
07EA22	Motor 6	2nd Floor West	All 2nd Floor	All West	
20AE54	Motor 7	1st Fl Drapery			
20B2F4	Motor 8	2nd Fl Drapery 1			
20B33A	Motor 9	2nd Fl Drapery 2			
GROUPS	INVERTED	DECIMAL	NAME		
010100	FFFEFE	1.1.0	ALL		
010101	FEFEFE	1.1.1	1st Floor East		
010102	FD FEFE	1.1.2	1st Floor South		
010103	FC FEFE	1.1.3	1st Floor West		
010104	FB FEFE	1.1.4	2nd Floor East		
010105	FA FEFE	1.1.5	2nd Floor South		
010106	F9 FEFE	1.1.6	2nd Floor West		
010107	F8 FEFE	1.1.7	All 1st Floor		
010108	F7 FEFE	1.1.8	All 2nd Floor		
010109	F6 FEFE	1.1.9	All East		
01010A	F5 FEFE	1.1.10	All South		
01010B	F4 FEFE	1.1.11	All West		
01010C	F3 FEFE	1.1.12	1st Fl Drapery		
01010D	F2 FEFE	1.1.13	2nd Fl Drapery 1		
01010E	F1 FEFE	1.1.14	2nd Fl Drapery 2		

V. INTEGRATION CONFIGURATION

LUTRON DEVICES

A Lutron Device is any physical or virtual keypad, timeclock, occupancy sensor or other user interface that contains a Device ID.

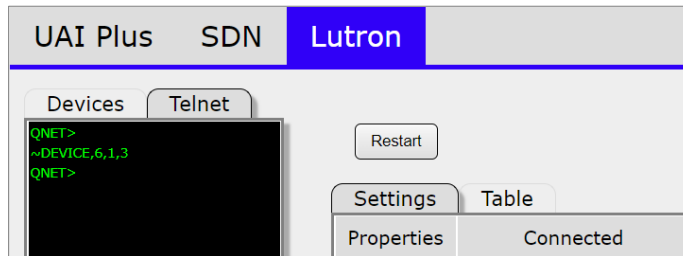

The Lutron Device ID consists of three parts:

DEVICE ID# – Individual Lutron Device identifier which can not be changed in the Somfy Connect UAI Plus

BUTTON# – The specific keypad button, timeclock event, occupancy sensor and other devices

COMMAND – Actions of each stage of a button press [Press, Release, Release for Hold, Hold (Multi)]

DEVICE TYPE	DEVICE ID#	BUTTON #	COMMAND
Keypad	Variable	Refer to keypad selection chart	3 = Press 4 = Release 5 = Release for hold 6 = Hold (Multi)
Timeclock	Variable	5	Event #
Occupancy Sensor	Variable	8	3 = Occupied 4 = Unoccupied

ADDING LUTRON DEVICES

There are two methods to add Lutron Device:

USING THE LUTRON INTEGRATION REPORT:

The Lutron Integration Report details all programmed device names, device IDs, button numbers and their text. Only the device ID is represented in the integration guide. Refer to the Lutron Integrator for the event number.

NOTE: The Lutron Integration Report should be provided by the Lutron Integrator. There is no Integration Report available for GRAFIK Eye QS, so the functions of the buttons must be provided by the Lutron Integrator.

- 1) In the Lutron Devices tab, select the Plus Sign for fields to open below
- 2) Enter the Device ID# from the Lutron Integration Report into the Device ID field
- 3) Enter the Device Name from the Lutron Integration Report or a unique name easily recognized in the Devices list into the Device Name field
- 4) Repeat steps 1-3 until all required devices are entered into the Lutron Devices list

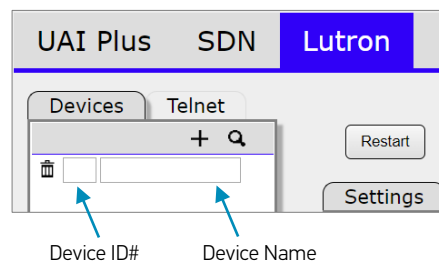

USING LISTENING MODE:

Listening Mode captures Lutron button presses in real time without the need of an Integration Report.

- 1) Make a live button press on the Lutron device to record into the Devices list
- 2) In the Lutron Devices tab, click the spyglass
 - The Device ID# and Name of the last recorded Lutron button press will appear in the Devices list
- 3) Enter a unique name easily recognized in the Devices list into the Device Name field
- 4) Repeat steps 1-3 until all required devices are entered into the Lutron Devices list

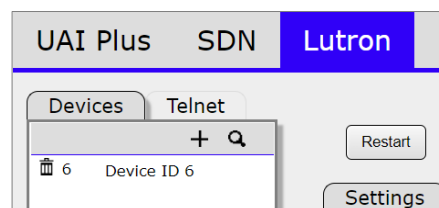

COMMAND MAPPING LUTRON DEVICES

Command mapping links Lutron button presses to trigger SDN group commands.

- 1) In the Table tab, right-click in the LUTRON ID column to open the Device window
- 2) Select the device to control this particular group
- 3) Enter the button number
- 4) Select the ACTION type from the dropdown:
 - PRESS
 - RELEASE
 - HOLD
 - MULTI-TAP
- 5) Click the download icon to record entry into the table

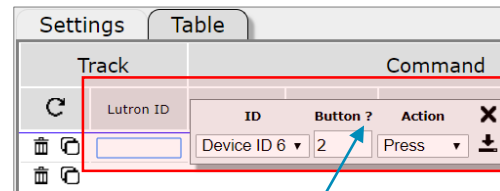

Click the Question Mark to access the Lutron Button Reference Chart

- 6) Select the SDN Group in the ADDRESS column
(See "SDN Integration Report" section of this guide)

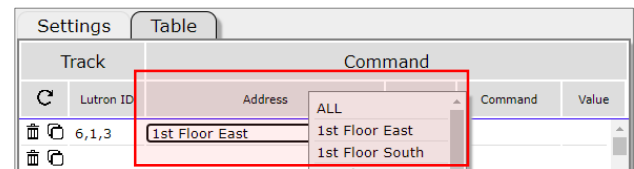

- 7) Select the DEVICE type from the dropdown:
 - MOTOR: Individual Button Programming
 - LED: not used
 - KEY: Group Keypad Programming

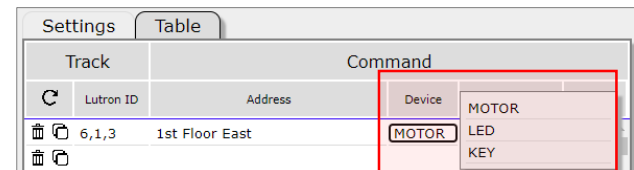

- 8) Select the SDN COMMAND from the dropdown:
 - CLOSE - Sends the motor group to the closed or 100% position
 - OPEN - Sends the motor group to the open or 0% Position
 - STOP - Stops the motor group when moving
 - RECALL - Sends a motor group to specified intermediate position
(1-16 to be entered in the Value column in the Lutron table)
 - STORE - Records a specific motor group location and sets a specified intermediate position
(1-16 to be entered in the Value column in the Lutron table)
 - GOTO - Sends a specific motor group to a specified percentage
(0-100 to be entered in the Value column in the Lutron table)
 - SEQUENCE - Cycles Close, Stop, and Open commands with a single button

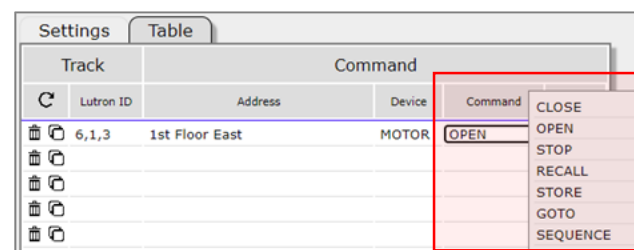

- 9) Enter the VALUE of the % or Intermediate Position
 - If using the GoTo or Recall commands, the Value of the % or Intermediate Position must be entered.

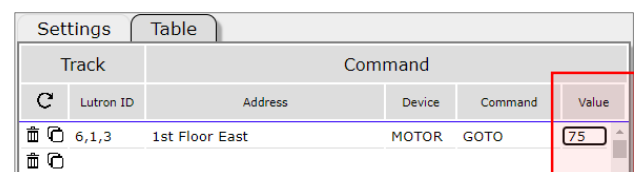

TROUBLESHOOTING:

Refer to the Lutron Telnet tab to confirm the connection is active.

(See "Lutron System Settings" section of this guide)

CONFIRM LUTRON BUTTON ID, BUTTON # AND ACTION:

With the Telnet tab open, make the physical button press to view the device information.

Reference this information to what is entered in the Lutron table.

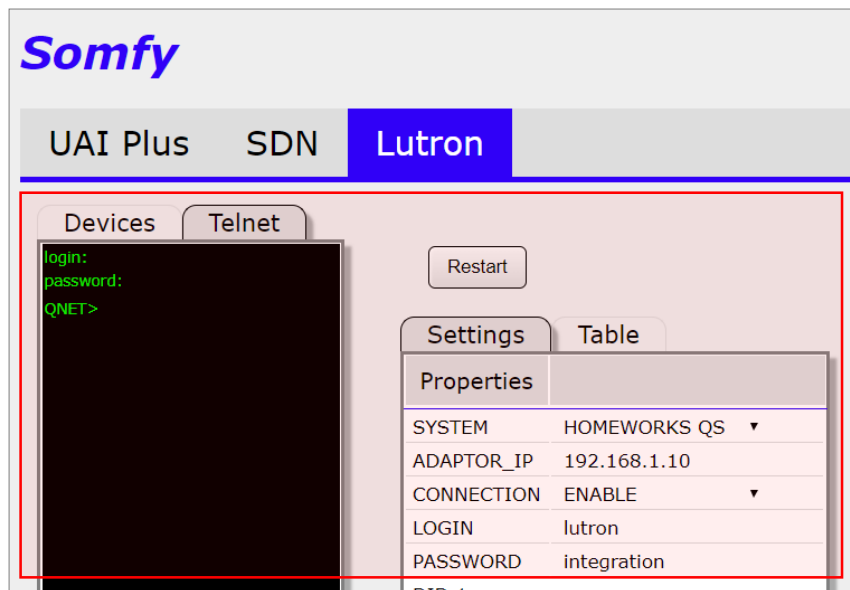

VALIDATION:

Test all keypad button presses to confirm proper functionality.

To test timeclock functions, refer to the Lutron Integrator to emulate command from Lutron terminal.

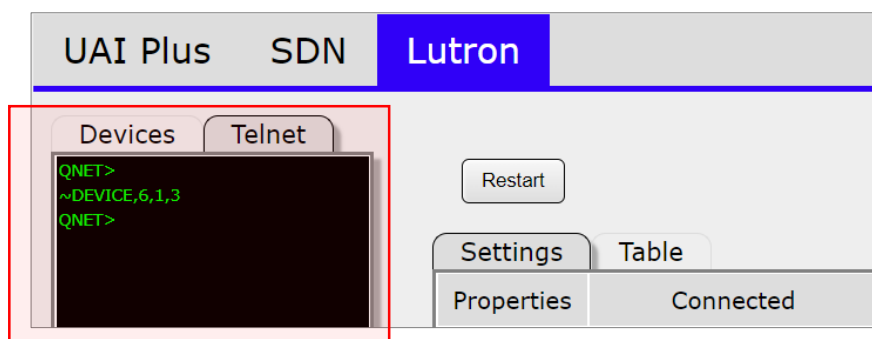

BUTTON PROGRAMMING EXAMPLES

Sequential Programming

- a. Right-click in the Device column then select MOTOR
- b. Right-click in the Command column then select SEQUENCE

NOTE: Sequence cycles Up, Stop, and Down commands. The Stop command will expire after 60 seconds and default to the next movement command after the button is pressed.

Track		Command		
Lutron ID	Address	Device	Command	
6,1,3	1st Floor East	MOTOR	SEQUENCE	CLOSE OPEN STOP RECALL STORE GOTO SEQUENCE

Single Action Programming

- a. Right-click in the Device column then select MOTOR
- b. Right-click in the Command column then select the required action to perform

NOTE: To send a group to a percentage, select GOTO in the Command dropdown then enter a percentage in the Value field. Only enter the number value (0-100).

Track		Command		
Lutron ID	Address	Device	Command	
6,1,3	1st Floor East	MOTOR	OPEN	CLOSE OPEN STOP RECALL STORE GOTO SEQUENCE

Group Control

- a. Right-click in the Device column then select KEY; repeat this step for each group button and be sure to change the Button ID each time
- b. Enter SDN Group Address; repeat this step for each group button

Track		Command			Value
Lutron ID	Address	Device	Command		
6,1,3	1st Fl Drapery	KEY			
6,2,3	2nd Fl Drapery 1	KEY			
6,3,3	2nd Fl Drapery 2	KEY			
6,18,3		MOTOR	CLOSE		
6,19,3		MOTOR	OPEN		

Create Group Raise / Lower

- a. Right-click in the Device column then select MOTOR
- b. Right-click in the Command column then select OPEN
- c. Click the Copy button to create an identical map below
- d. Edit the Lutron ID and change the Command column from OPEN to CLOSE

Momentary Button Press *Requires both a Multi-tap and a Release function added to the Lutron table.

For Hold / Release Command

- a. Right-click in the Lutron ID column, set Action to MULTI-TAP then set the Button
- b. Right-click in the Device column then select MOTOR
- c. Right-click in the Command column then select a movement
- d. Right-click in the Lutron ID column then set Action to RELEASE (set the same Button from previous steps)
- e. Right-click in the Device column then select MOTOR
- f. Right-click in the Command column then select STOP

SOMFY® is the leading global manufacturer of strong, quiet motors with electronic and app controls for interior window coverings and exterior solar protections. Over 270 million users worldwide enjoy the more than 170 million motors produced by Somfy. During the past 50 years, Somfy engineers have designed products for both the commercial and residential markets to motorize window coverings such as interior shades, wood blinds, draperies, awnings, rolling shutters, exterior solar screens and projection screens. Somfy motorization systems are easily integrated with security, HVAC and lighting systems providing total home or building automation.

FOR QUESTIONS OR ASSISTANCE PLEASE CONTACT TECHNICAL SUPPORT:

(800) 22-SOMFY (76639)

technicalsupport_us@somfy.com

SOMFY SYSTEMS INC

SOMFY NORTH AMERICAN HEADQUARTERS

121 Herrod Blvd.

Dayton, NJ 08810

P: (609) 395-1300

F: (609) 395-1776

FLORIDA

1200 SW 35th Ave.

Boynton Beach, FL 33426

F: (561) 995-7502

CALIFORNIA

15301 Barranca Parkway

Irvine, CA 92618-2201

F: (949) 727-3775

SOMFY ULC

SOMFY Canada Division

5178 Everest Drive

Mississauga, Ontario L4W2R4

P: (905) 564-6446

F: (905) 238-1491

www.somfypro.com

A BRAND OF **SOMFY** GROUP

© Somfy Systems, Inc. 10/2020. All brands, products and trademarks are the property of their respective owners.